

STAR WARS

SHATTERPOINT™

SWP03 (A)-COUNT DOOKU

DAS HIER ZUERST LESEN

Löse die Miniatureteile mit einem Seitenschneider aus dem Gitter. Entferne dann mit einem scharfen Bastelmesser vorsichtig die Reste des Gussgitters und die Gussgrate. Prüfe vor dem Kleben, ob alles zusammenpasst, und verwende sparsam Modellbaukleber, um die Teile zu befestigen.

SEI TEIL DER COMMUNITY

Teile unter #ShatterPaint Fotos von deinen Miniaturen und sei Teil der Star Wars: Shatterpoint-Community!

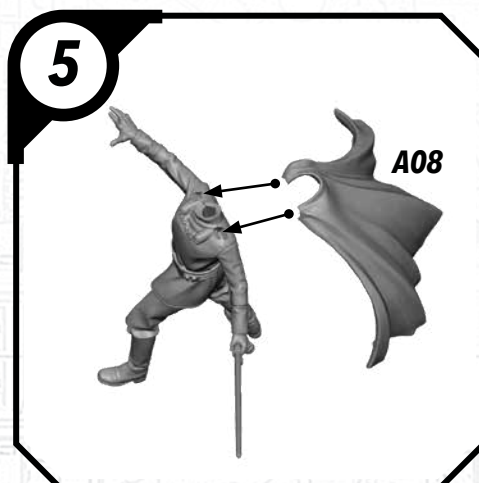
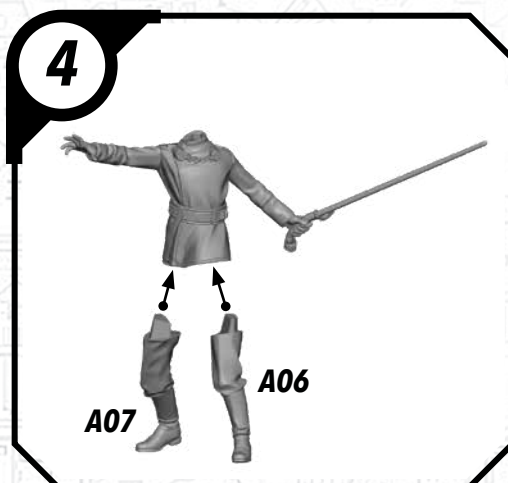
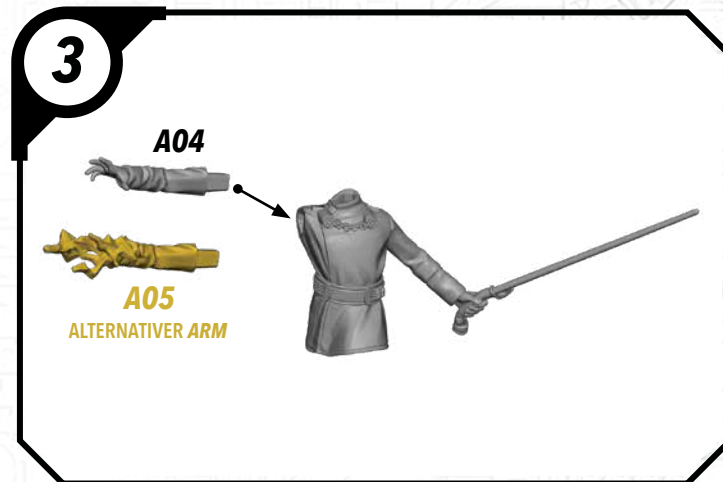
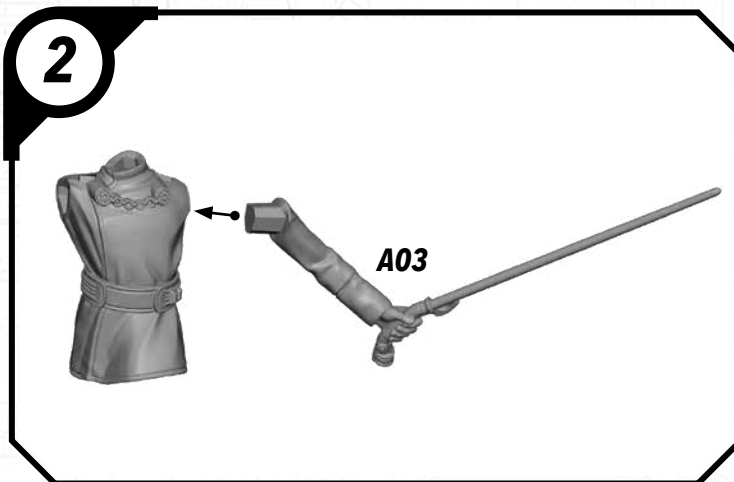
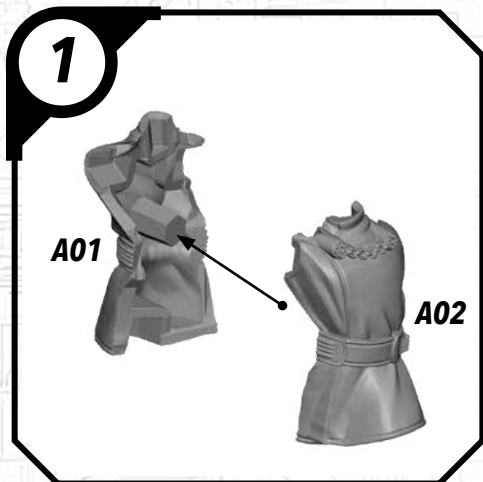
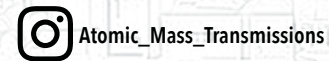

ALLE TEILE SOLLTEN MIT KUNSTSTOFFKLEBER ZUSAMMENGEFÜGT WERDEN. DRUCKEN UND FOTOKOPIEREN FÜR DEN PERSÖNLICHEN GEBRAUCH GESTATTET.

SWP03 (B)-JANGO FETT

1

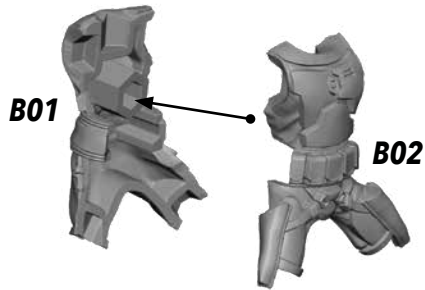

2

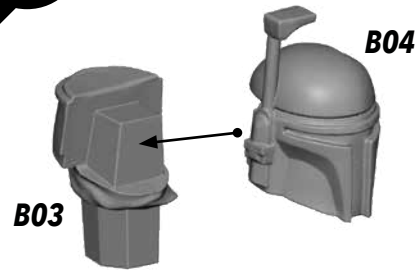

3

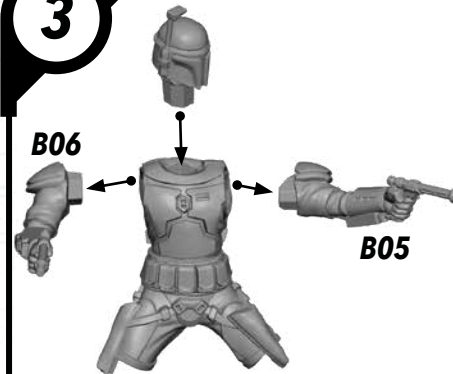

4

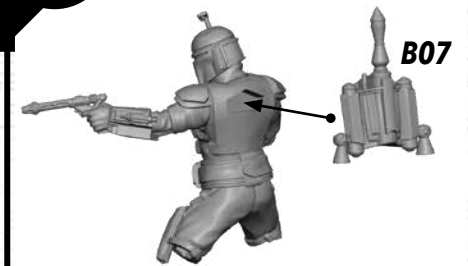

5

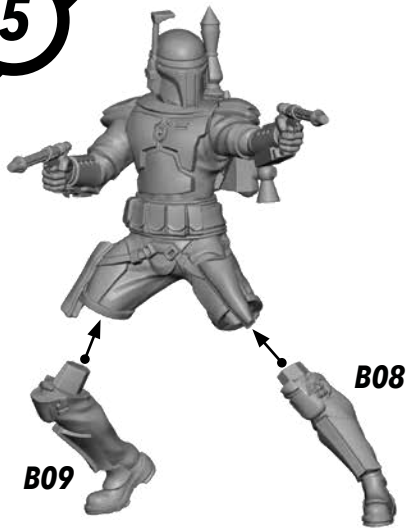

7



FERTIG



ALLE TEILE SOLLTEN MIT KUNSTSTOFFKLEBER ZUSAMMENGEFÜGT WERDEN. DRUCKEN UND FOTOKOPIEREN FÜR DEN PERSÖNLICHEN GEBRAUCH GESTATTET.

SWP03 (C)-MAGNA-WÄCHTER (POSE A)

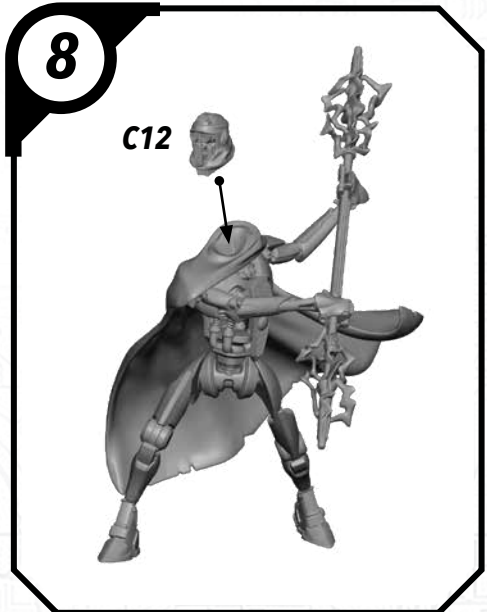
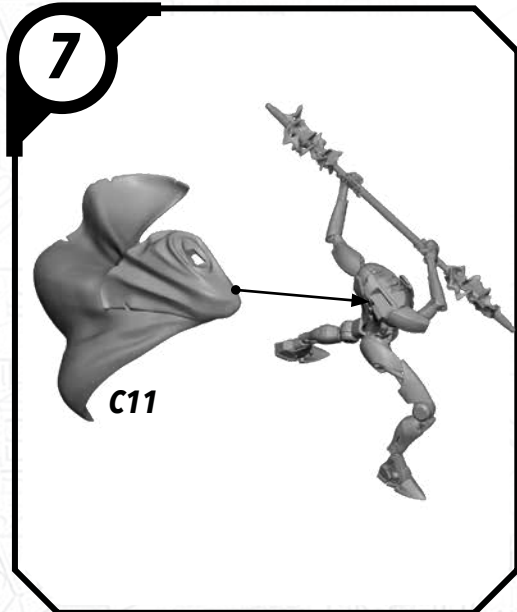
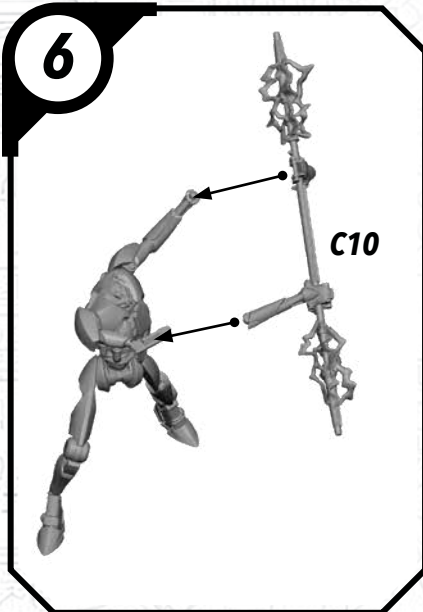
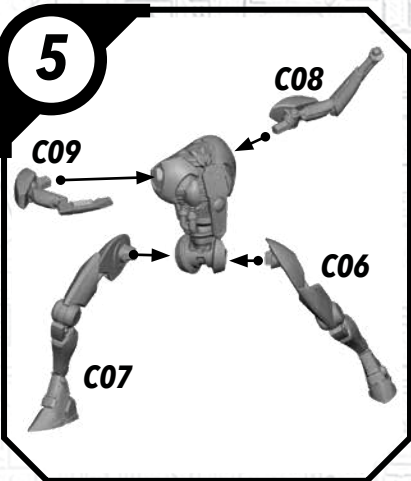
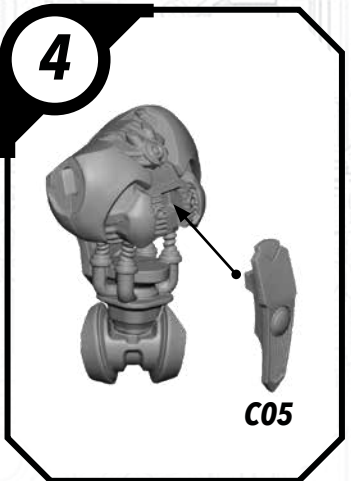
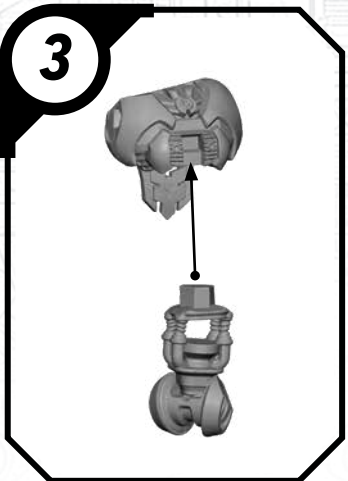
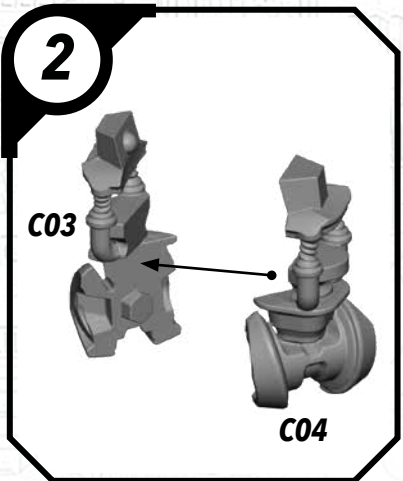
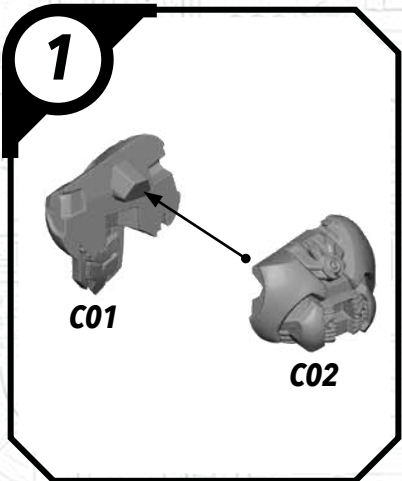

ALLE TEILE SOLLTEN MIT KUNSTSTOFFKLEBER ZUSAMMENGEFÜGT WERDEN. DRUCKEN UND FOTOKOPIEREN FÜR DEN PERSÖNLICHEN GEBRAUCH GESTATTET.

SWP03 (C)-MAGNA-WÄCHTER (POSE B)

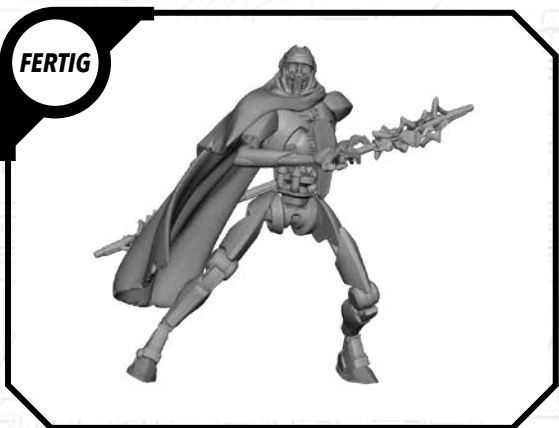
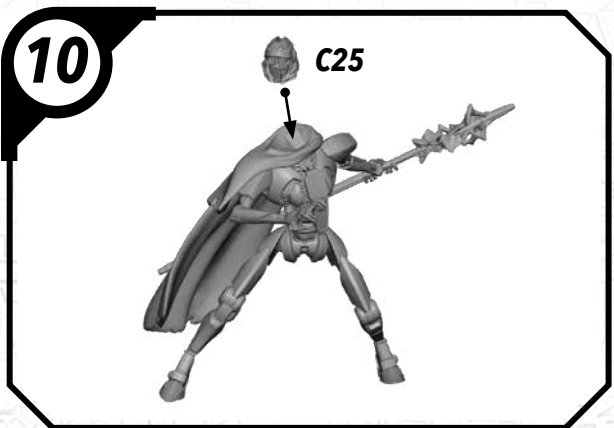
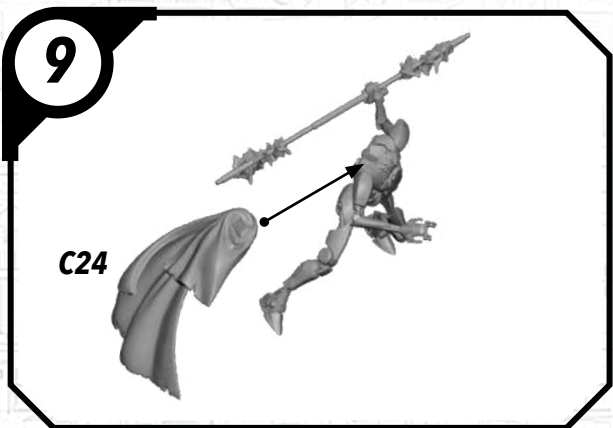
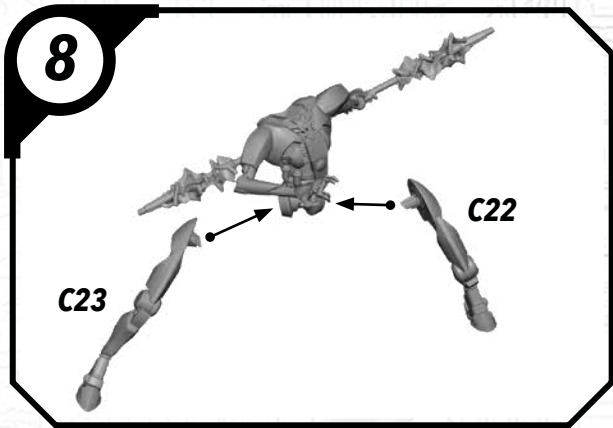
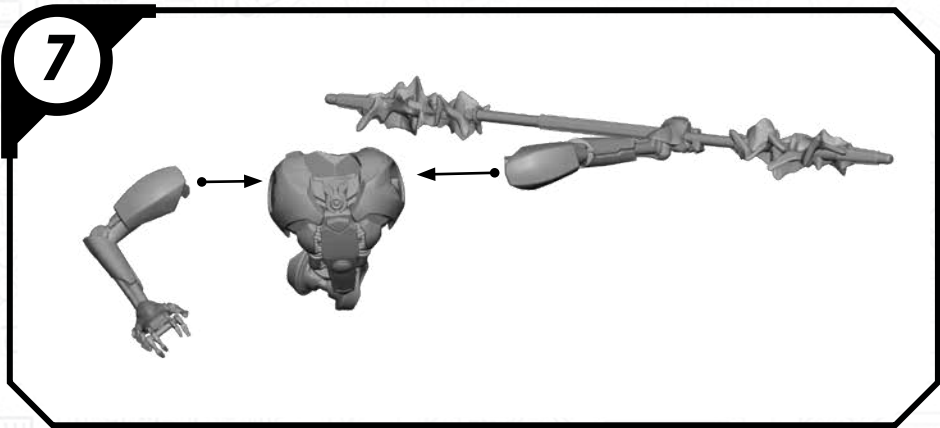
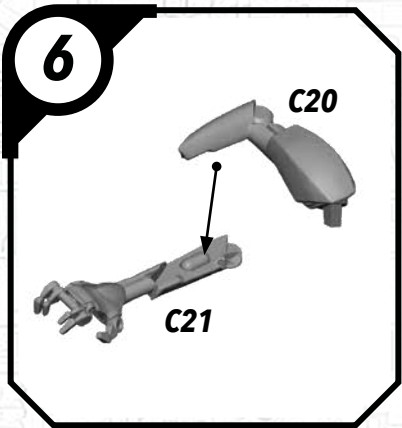
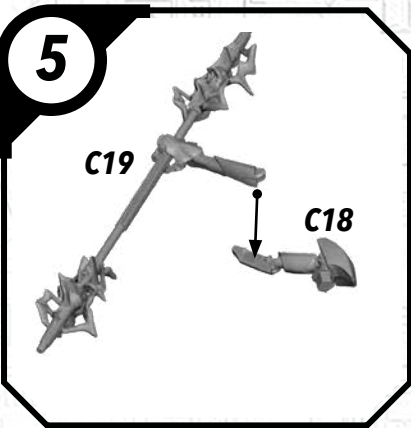
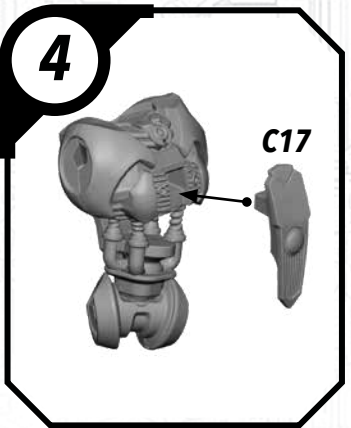
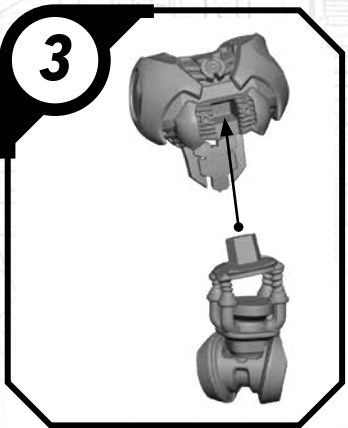
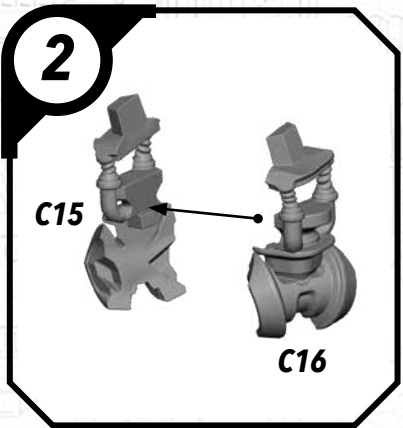
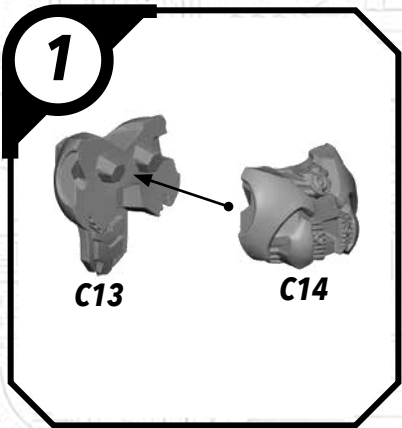

ALLE TEILE SOLLTEN MIT KUNSTSTOFFKLEBER ZUSAMMENGEFÜGT WERDEN. DRUCKEN UND FOTOKOPIEREN FÜR DEN PERSÖNLICHEN GEBRAUCH GESTATTET.