

STAR WARSM

LEGIONSM

ABGESTÜRZTER X-FLÜGLER ZUSAMMENBAU

DAS HIER ZUERST LESEN

Löse vor dem Aufbau die Teile der Miniaturen mit einem Seitenschneider aus dem Gussgitter. Entferne dann mit einem scharfen Bastelmesser vorsichtig die Reste des Gussgitters und die Gussgrate. Prüfe vor dem Kleben, ob alles zusammenpasst, und verwende sparsam Modellbaukleber, um die Teile zu befestigen. Viel Spaß!

SEI TEIL DER COMMUNITY

Teile unter #MyStarWarsLegion Fotos von deinen Miniaturen und sei Teil der *STAR WARS: LEGION*-Community!



AtomicMassGames



AtomicMassGames



Atomic_Mass_Transmissions

SCHRITT 1

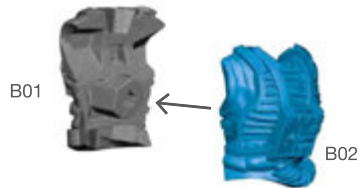

SCHRITT 2

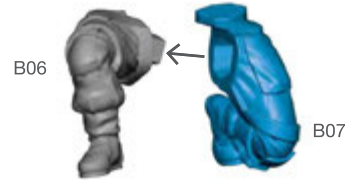

SCHRITT 3

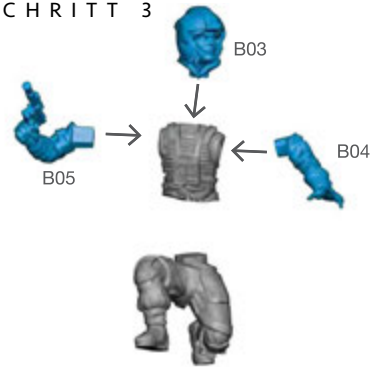

FERTIG



ABGESTÜRZTER X-FLÜGLER ZUSAMMENBAU (A)

SCHRITT 1

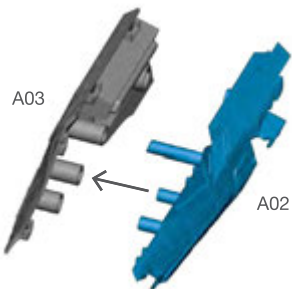

SCHRITT 2

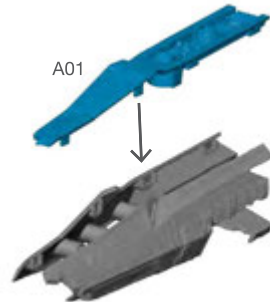

SCHRITT 3

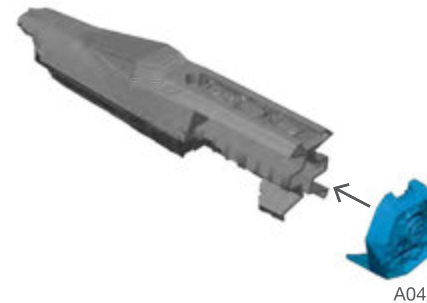

SCHRITT 4



ABGESTÜRZTER X-FLÜGLER

ZUSAMMENBAU (A)

SCHRITT 5

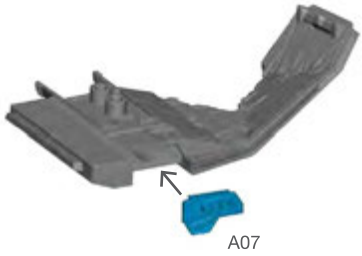

SCHRITT 6

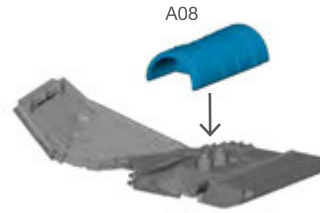

SCHRITT 7



SCHRITT 8



SCHRITT 9

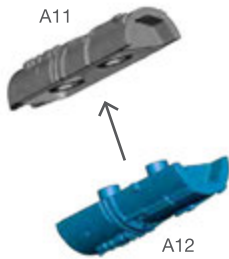

SCHRITT 10

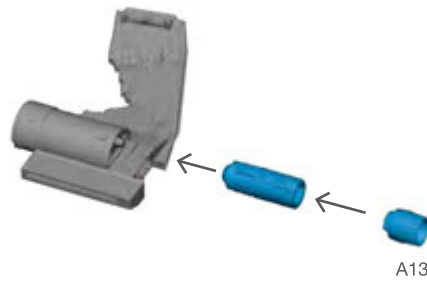

SCHRITT 11

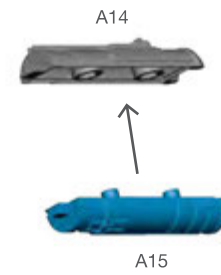

SCHRITT 12

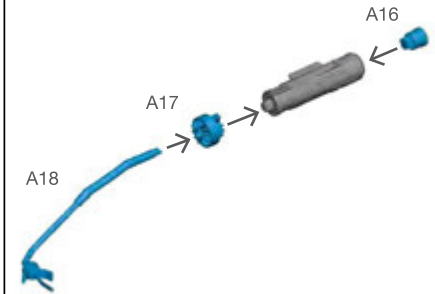

SCHRITT 13

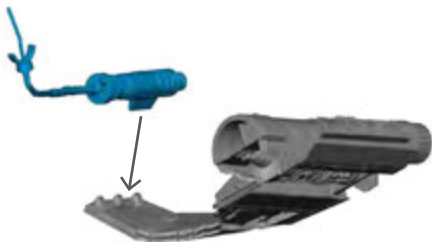

SCHRITT 14

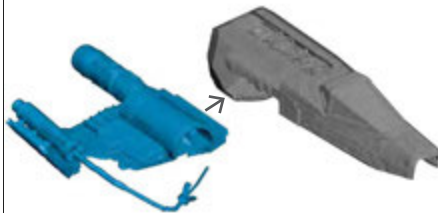

SCHRITT 15

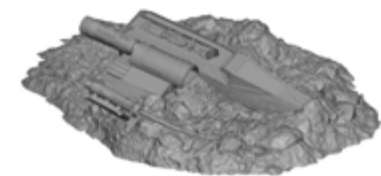
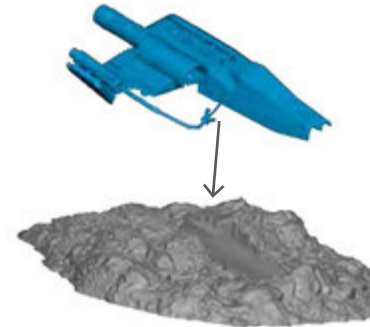

ABGESTÜRZTER X-FLÜGLER

ZUSAMMENBAU (A)

